

EasyTREK

SP-300, SP-300 Ex
two-wire compact ultrasonic level transmitter

Installation and Programming manual



Manufacturer:

NIVELCO Process Control Co.

H-1043 Budapest, Dugonics u. 11.





Tel.: (36-1) 889-0100 Fax: (36-1) 889-0200

E-mail: sales@nivelco.com www.nivelco.com

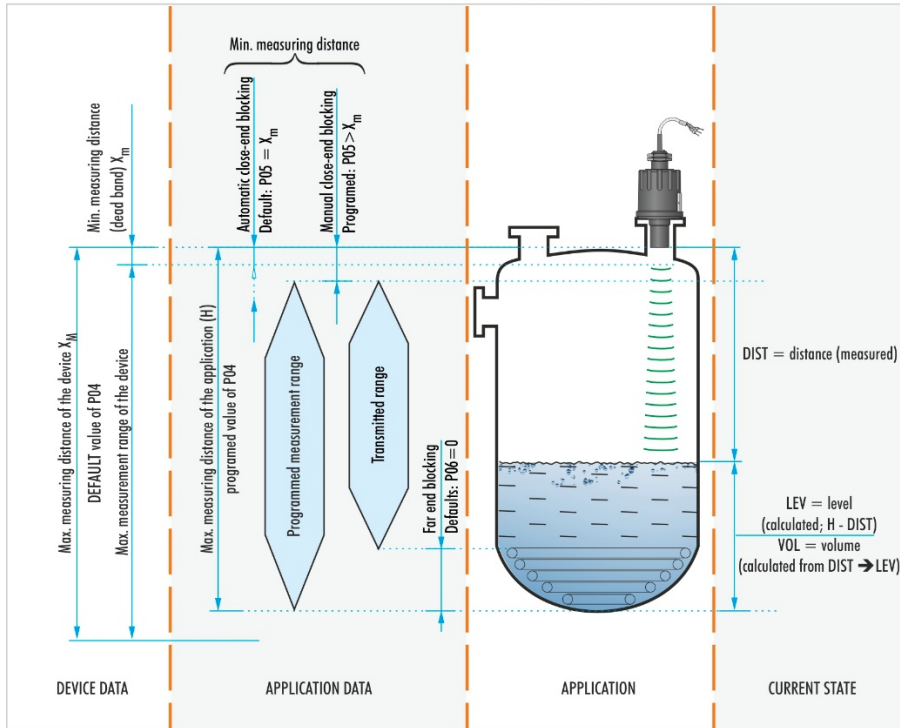

BASIC CONCEPTS AND ELEMENTS



	APPROVALS	Reference document number
	BKI ATEX, Certificate No.: BKI16ATEX0017X/2	spa380hu2111pb
 Segurança  	INMETRO, Certificate No.:DNV 14.0167 X – Rev. 02	spa3804p0600p_08
	Ex Russia, Certificate No.: RU C-HU.MF62.B.04399	spa3804m0600p_03

CONTENTS

1. INTRODUCTION	6	5.3. Programming.....	16
2. TECHNICAL DATA.....	7	5.3.1. Measurement configuration.....	16
2.1 General data.....	7	5.3.2. Current Output.....	22
2.2 Additional data for explosion-proof certified versions	8	5.3.3. Relay Output	23
2.2.1 ATEX approval No.: BK116ATEX0017X/2.....	8	5.3.4. Digital communication	24
2.2.2 INMETRO approval No.: DNV 14.0167 X – Revision 02	8	5.3.5. Measurement optimization	24
2.3 Special data of the transducers.....	9	5.3.6. Data logger.....	28
2.4 Accessories	9	5.3.7. Volume (content) measurement.....	32
2.5 Order codes (Not all combinations are available).....	9	5.3.8. Open channel flow measurement	33
2.6 Dimensions.....	10	5.3.9. 32-Point linearization.....	39
3. INSTALLATION	11	5.3.10. Informational parameters (read out parameters)	40
3.1 Liquid Level Measurement.....	11	5.3.11. Additional parameters of the flow metering.....	41
3.2 Open channel flow measurement	13	5.3.12. Supplementary parameter of the logger.....	41
4. WIRING	13	5.3.13. Other parameters	41
5. PUTTING INTO OPERATION.....	14	6. MAINTENANCE, REPAIR, AND STORAGE CONDITIONS ..	42
5.1. Usage	14	6.1 Software upgrade	42
5.2. Special conditions of safe use.....	15	7. ERROR CODES.....	43
		8. PARAMETER TABLE.....	44
		9. SOUND VELOCITY VALUES IN DIFFERENT GASES	46



Thank you for choosing NIVELCO instrument!

1. INTRODUCTION

Application

The **EasyTREK** compact ultrasonic level transmitters from NIVELCO are excellent tools for level measurement of liquids.

Level measurement technology based on the non-contacting ultrasonic principle is especially suited for applications where, for any reason, no physical contact can be established to the surface of the material to be measured.

Principle of Operation

The ultrasonic level metering technology is based on the principle of measuring the time required for the ultrasound pulses to make a round trip from the sensor to the level to be measured and back. The sensor emits an ultrasonic pulse train and receives the echoes reflected. The intelligent electronic device processes the received signal by selecting the echo reflected by the surface and calculates from the time of flight the distance between the sensor and the surface which constitutes the basis of all output signals of the **EasyTREK**.

Minimum measuring distance (X_m) is determined by the design of the unit within which the measurement is not possible (Dead Zone) its value is according with **P05** on page 18. Since measurement is impossible within this range material should not get into this zone.

Maximum measuring distance (X_M) is the greatest distance (determined by the design of the unit) which can be measured by the unit under ideal conditions. (See parameter **P04** on page 17). Maximum measuring distance of the actual application (H) must not be greater than X_M .

A **Total beam angle** of $5...7^\circ$ at -3 dB as is featured by most of **NIVELCO's** SenSonic transducers ensuring a reliable measurement in narrow silos with uneven side walls as well as in process tanks with various protruding objects. Furthermore, as a result of the narrow beam angle – the emitted ultrasonic signals have an outstanding focusing – deep penetration through gases, vapor and foam is ensured.

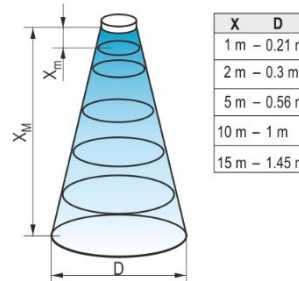

Diameters corresponding to 5° beam angle.

2. TECHNICAL DATA

2.1 GENERAL DATA

Transducer/housing materials	Polypropylene (PP), PVDF, PTFE / PP	
Process temperature	PP, PVDF and PTFE transducers -30...+90 °C [-20...+190 °F]	
Ambient temperature	-30...+80 °C [-20...+175 °F]	
Pressure ⁽¹⁾ (Absolute)	0.5...3 bar (0.05...0.3 MPa) [7.25...43.5 psi]	
Seal	PP transducer: EPDM; All other transducer versions: FPM	
Ingress protection	IP68	
Power supply	12 ⁽³⁾ ...36 V DC with HART communication	48 mW...720 mW, Galvanic isolation; protection against surge transients
Accuracy ⁽²⁾	± (0.2% of the measured distance plus 0.05% of the range)	
Resolution	Depending on the measured distance: < 2 m: 1 mm, 2-5 m: 2 mm, 5-10 m: 5 mm, > 10 m: 10 mm [< 6.5 ft: 40 mil, 6.5 ft to 16 ft: 78 mil 16 ft to 32 ft: 200 mil > 32 ft: 400 mil]	
Outputs	Analogue: 4...20 mA, (3.9...20.5 mA), $R_{tmax} = (U_t - 11,4 V) / 0.02 A$, Galvanic isolation; protection against surge transients	
	SPDT relay, 30 V / 1 A DC; 48 V / 0.5 A AC	
	Serial communication: HART interface (terminal resistor 250 Ohm)	
Electrical connection	6 x 0.5 mm ² shielded cable Ø6 mm x 5 m (available max. length 30 m) [6 x AWG20 shielded cable Ø0.25 inch x 16.5 feet (available max. length 100 feet)]	
Electrical protection	Class III SELV	

- (1) For pressures below 1 bar representative of NIVELCO should be consulted.
 (2) Under optimal circumstances of reflection and stabilised transducer temperature.
 (3) Only partial operation is provided. Reliable operation without any restrictions is guaranteed at >13.4 V terminal voltage.

2.2 ADDITIONAL DATA FOR EXPLOSION-PROOF CERTIFIED VERSIONS

2.2.1 ATEX APPROVAL No.: BKI16ATEX0017X/2

Type	SP□-3□□-7Ex SP□-3□□-8Ex
Ex marking (ATEX)	⊕ II 1 G Ex ia IIB T6...T5 Ga
Intrinsically safe data	$C_i \leq 28 \text{ nF}$, $L_i \leq 200 \text{ } \mu\text{H}$, $U_i \leq 30 \text{ V}$, $I_i \leq 140 \text{ mA}$, $P_i \leq 1 \text{ W}$
Ex power supply, loading	$U_o \leq 30 \text{ V}$, $I_o \leq 140 \text{ mA}$, $P_o \leq 1 \text{ W}$
Medium temperature	For PP transducer $-20...+70 \text{ }^\circ\text{C}$ [$-4...+158 \text{ }^\circ\text{F}$], for PVDF transducer $-20...+80 \text{ }^\circ\text{C}$ [$-4...+176 \text{ }^\circ\text{F}$] Temp. class T6, for PTFE transducer $-30...+90 \text{ }^\circ\text{C}$ [$-22...+194 \text{ }^\circ\text{F}$] Temp. class T5,
Ambient temperature	$-20...+70 \text{ }^\circ\text{C}$ [$-4...+158 \text{ }^\circ\text{F}$]

2.2.2 INMETRO APPROVAL No.: DNV 14.0167 X – REVISION 02

Type	SP□-3□□-7Ex SP□-3□□-8Ex
Ex marking (INMETRO)	Ex ia IIB T6...T5 Ga
Intrinsically safe data	$C_i \leq 28 \text{ nF}$, $L_i \leq 200 \text{ } \mu\text{H}$, $U_i \leq 30 \text{ V}$, $I_i \leq 140 \text{ mA}$, $P_i \leq 1 \text{ W}$
Ex power supply, loading	$U_o < 30 \text{ V}$, $I_o < 140 \text{ mA}$, $P_o < 1 \text{ W}$
Medium temperature	For PP transducer $-20...+70 \text{ }^\circ\text{C}$ [$-4...+158 \text{ }^\circ\text{F}$], for PVDF transducer $-20...+80 \text{ }^\circ\text{C}$ [$-4...+176 \text{ }^\circ\text{F}$] Temp. class T6, for PTFE transducer $-30...+90 \text{ }^\circ\text{C}$ [$-22...+194 \text{ }^\circ\text{F}$] Temp. class T5,
Ambient temperature	$-20...+70 \text{ }^\circ\text{C}$ [$-4...+158 \text{ }^\circ\text{F}$]

2.3 SPECIAL DATA OF THE TRANSDUCERS

SPECIAL DATA FOR PP, PVDF AND PTFE TRANSDUCERS (ALSO APPLIES TO EX MODELS)

Type	SP□-39□-□		SP□-38□-□		SP□-37□-□		SP□-36□-□	SP□-34□-□	SP□-32□-□
Transducer material	PP, PVDF	PTFE	PP, PVDF	PTFE	PP, PVDF	PTFE	PP or PVDF		
Max measuring distance * (X_m) [m (ft)]	4 (13)	3 (10)	6 (20)	5 (17)	8 (26)	6 (20)	10 (33)	15 (49)	25 (82)
Min. measuring distance* (Dead band) (X_m) [m (in)]	0.2 (8)	0.25 (10)		0.35 (14)			0.45 (18)	0.6 (24)	
Total beam angle (-3 dB)	6°		5°		7°		5°		7°
Measurement frequency	80 kHz				50 kHz		60 kHz	40 kHz	20 kHz
Upper process connection	1" BSP thread								
Lower process connection	1½" BSP / NPT thread		2" BSP / NPT thread				-		

* (from the transducer face)

2.4 ACCESSORIES

- Warranty Card
- Installation and Programming Manual
- EU Declaration of Conformity

2.5 ORDER CODES (NOT ALL COMBINATIONS ARE AVAILABLE)

EasyTREK S P □ - 3 □ □ - □

TRANSDUCER MATERIAL	CODE	RANGE m	CODE	PROCESS CONNECTION	CODE	OUTPUT / CERTIFICATES	CODE
PP	A	25	2	1"; 2" BSP thread	0	4...20 mA / HART / LOGGER	3
PVDF	B	15	4	2" NPT thread	N	4...20 mA / HART	4
PTFE / PP (only for SP-39/38/37)	T	10	6	1" BSP quick conn. / PP	F	4...20 mA / HART / LOGGER / Ex	7
		6; 8*	7	Bracket 200 mm	K	4...20 mA / HART / Ex	8
		5; 6*	8	Bracket 500 mm	L	4...20 mA / Relay / HART	H
		3; 4*	9	Bracket 700 mm	M	4...20 mA / Relay / HART / LOGGER	A

The order code of an Ex-version should end in 'Ex'

* Measuring range depends on the material of the transducer

2.6 DIMENSIONS

EasyTREK
SP□-39□-□ /
PP, PVDF, PTFE

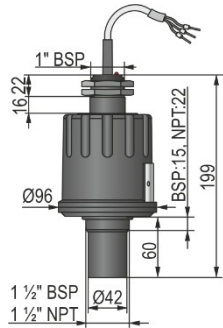

EasyTREK
SP□-38□-□ /
PP, PVDF, PTFE

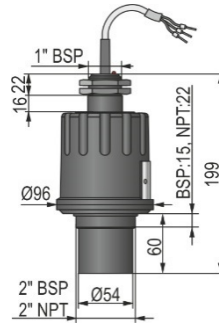

EasyTREK
SP□-37□-□ /
PP, PVDF, PTFE

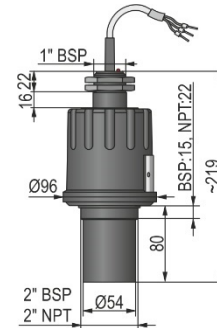

EasyTREK
SP□-36□-□ /
PP, PVDF

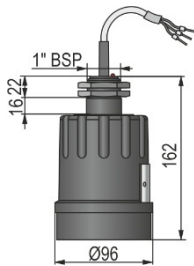

EasyTREK
SP□-34□-□ /
PP, PVDF

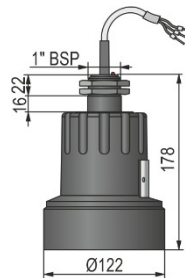

EasyTREK
SP□-32□-□ /
PP, PVDF

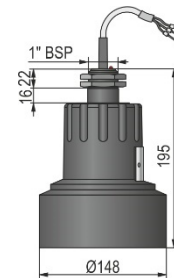

3. INSTALLATION

3.1 LIQUID LEVEL MEASUREMENT

POSITION

The ideal position of the **EasyTREK** is on the radius $r = (0.3...0.5) R$ of the (cylindrical) tank / silo.
(Take also sonic cone on page 5 into consideration.)

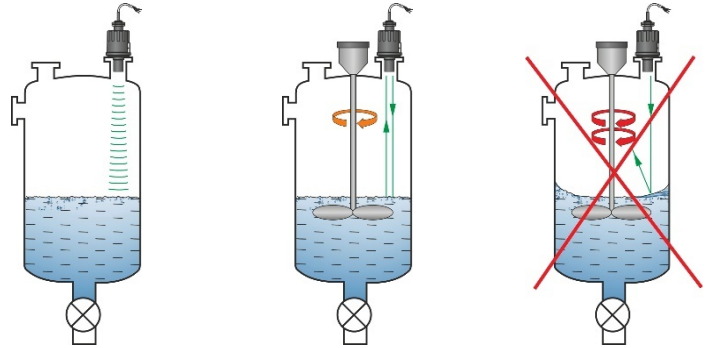

SENSOR ALIGNMENT

The sensor face has to be parallel to the surface of the liquid within $\pm 2^\circ \dots 3^\circ$.

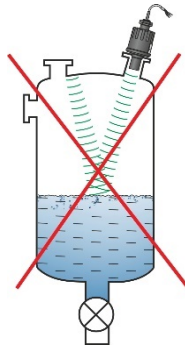

TEMPERATURE

Make sure that the transmitter is protected against overheating by direct sunshine.

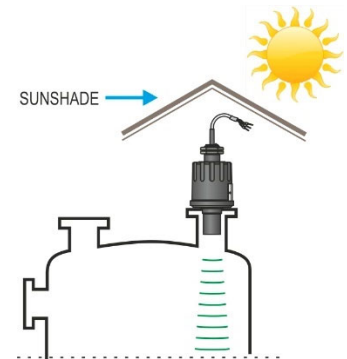

OBSTACLES

Make sure that no objects (cooling pipes, bracing members, thermometers etc.) protrude into the sensing cone of the ultrasonic beam.

Remark: EasyTREK programming allows one fixed object that would otherwise disturb the measurement to be blocked out. (see P29 of programming).

FOAM

Foaming of the liquid surface may render ultrasonic level metering impossible. If possible, a location should be found, where foaming is the least (device should be located as far as possible from liquid inflow) or a stilling pipe or well should be used.

STAND-OFF

The structure of the standoff pipe should be rigid; the inner rim where the ultrasonic beam leaves the pipe should be rounded.

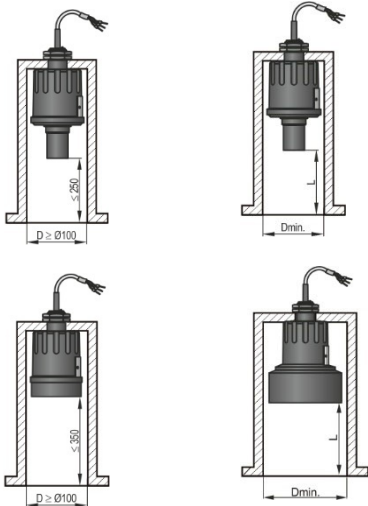

WIND

Intensive air (gas) movements in the vicinity of the ultrasonic cone is to be avoided. A strong draft of wind may "blow away" the ultrasound. Devices with lower measuring frequency (40, 20 kHz) are recommended.

FUMES / VAPOURS

For closed tanks containing chemicals or other liquids, which creates fume/gases above the liquid surface especially for outdoor tanks exposed to the sun, a strong reduction of the nominal measuring range of the ultrasonic device is to be considered during device selection. Devices with lower measuring frequency (40, 20 kHz) are recommended in these cases.



L	D _{min}		
	SP□-39□	SP□-38□	SP□-37□
150	50	60	60
200	50	60	75
250	65	65	90
300	80	75	105

L	D _{min}	
	SP□-34□	SP□-32□
90	*	*
200	*	*
350	*	*
500	*	*

* For values contact your distributor

3.2 OPEN CHANNEL FLOW MEASUREMENT

- The unit is suitable for open channel flow measurement with the constructive works listed in 5.3.8.
- For ultimate accuracy, install the sensor as close as possible above the expected maximum water level (see minimum measuring range).
- Install the unit in a place defined by the characteristics of the metering channel along the longitudinal axis of the flume or weir. In case of Parshall flumes supplied by NIVELCO the location of the sensor is marked.
- In some cases, foam may develop on the surface. Make sure that the surface, opposite to the sensor, remains free of foam for proper sound reflection.
- The unit should be fixed so that its position would not change.
- From measurement accuracy point of view the length of the channel sections preceding and following the measuring flume and their method of joining to the measuring channel section are of critical importance.
- Despite of the most careful installation, the accuracy of flow metering will be lower than that of specified for the distance measurement. The features of the flume or weir applied will determine it.
- Devices should be protected against overheating due to direct sunshine by using sunshades.

4. WIRING

- Make sure the terminals in the box are not under power
(Use shielded cable 6 x 0.5 mm² [20 AWG] suggested in the technical data or stronger).
- After powering the necessary programming can be performed.

Wire colors:

Green - relay C1 output independent)	White - I,	one of the points of current loop, power supply and HART (polarity independent)
Yellow - relay CC output	Brown - I,	other point of current loop, power supply and HART (polarity independent)
Grey - relay C2 output	Black - GND,	functional earthing and shielding point

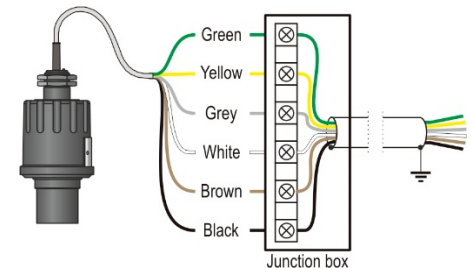
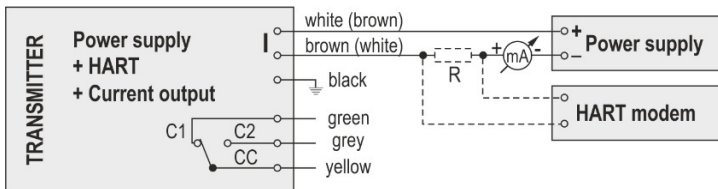

Extension of the integrated cable:

Should extension be needed the use of connection box is suggested. The shielding of the two cables should be connected and grounded at the signal processing device.

5. PUTTING INTO OPERATION

5.1. USAGE

Subsequent to powering the correctly wired device would start to tick and after 10...20 s ECHO LED go on and 4...20 mA signal appears on the current output. Measurement will be according to the factory setting. The factory setting is throughout apt to check proper working and to perform simple measurement tasks but features residing in the unit can only be utilized by adjusting the **EasyTREK** to the application by programming. For sound knowledge of the operation features and proper solving of difficult measurement applications the parts of the programming should carefully be studied.

LED indication:

- **ECHO-LED**
ON, if the unit detects proper echo
- **COM-LED**
Blinking on HART communication
Is ON in the state of remote programming

IrDA - Infrared communication port for logger readout, diagnostics and software upgrade

Device can be reset to factory setting. Default of **EasyTREK** SP-300 is the following:

- ⇒ Measurement: level (LEV)
- ⇒ Zero level assigned to the maximum distance
- ⇒ Current output proportional to the level
- ⇒ 4 mA and 0% assigned to zero level.
- ⇒ 20 mA and 100% assigned to the maximum level (minimum distance)
- ⇒ Error indication by the current output: holds last value.
- ⇒ Damping: 60 s.

View of the transmitter neck from above:

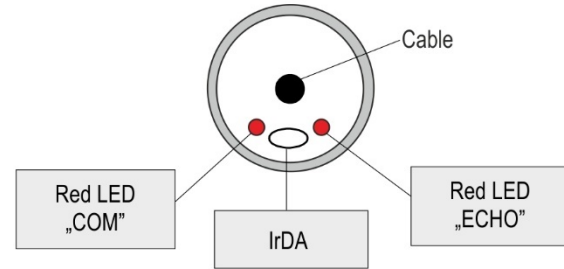

5.2. SPECIAL CONDITIONS OF SAFE USE

Diameter of the cable should match the cable conduit.

The cable outside the unit should be fixed so that it should be free of loading.

The terminal box should be selected in accordance with the electrical class of the area.

The device should read or programmed through IR port only outside of the explosive hazardous atmosphere because the infrared interface connected to the computer is not an explosion-proof apparatus.

Transmitter can only be powered by certified intrinsically safe current loop.

The PTFE enclosure of the transducer is plastic that can be loaded electrostatically therefore:

- Filling and emptying speed should be selected according to the medium
- Fog development of the dangerous material during filling should be avoided.
- Cleaning of the plastic enclosure is not allowed in hazardous space.

The device can be mounted into tanks with up to 3 bar (43.5 psi) process pressure. The apparatus is not suitable as a fire-resistant barrier between the inside and the outside area. After mounting the unit, pressure test of the system should be carried out on a regular basis in accordance to the local regulations at 1.5 times higher pressure than the nominal pressure value.

5.3. PROGRAMMING

The HART interface of the EasyTREK provides for access to the whole parameter set and possibility of their programming. Parameter set can be reached in two different ways: by the use of the

- **EView2** software run on the PC connected through HART modem to the loop or
- **NIVELCO** made **MultiCONT** multi-channel process control unit.

Since these access methods differ in their form and handling present manual does not review them. The information is contained in the relevant descriptions and user's manuals.

5.3.1. MEASUREMENT CONFIGURATION

P00: - c b a Engineering Units

FACTORY DEFAULT: 000

*Programming of this parameter will result in loading the factory default with the corresponding engineering units.
Therefore all parameters should be set again!*

a	Operation
0	Liquid level measurement

b	Engineering units (according to "c")	
	Metric	US
0	m	ft
1	cm	inch

c	Calculation system
0	metric
1	US

Parameter value „a” will determine the basic measurement value that will be transmitted. Subsequently values for the relays are also relating to these quantities.

a	Measurement mode	Transmitted value	Display symbol
0	Distance	Distance	DIST
1	Level	Level	LEV
2	Level %		LEV%
3	Volume	Volume	VOL
4	Volume %		VOL%
5	Flow	Flow	FLOW

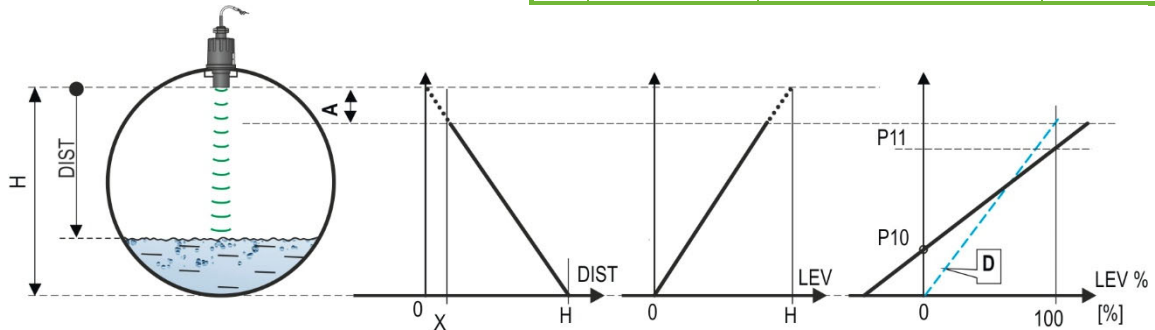

Transmitted value	DIST	LEV=H-DIST	LEV% = $LEV \cdot \frac{P11-P10}{H-X_m} + P10$
Parameters to set	P00 P01(a) = 0 P05 ≥ X _m	P00 P01(a) = 1 P04 = H P05 ≥ X _m	P00 P01(a) = 2 P04 = H P05 ≥ X _m P10 = X _{0%} P11 = X _{100%}

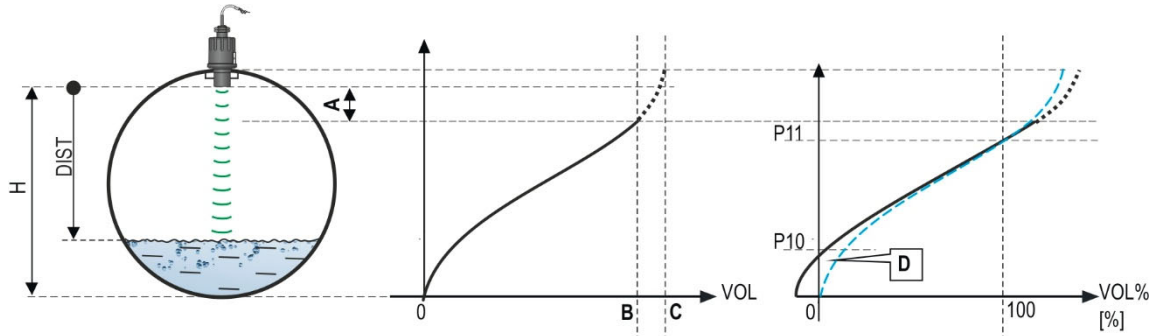

Transmitted value	VOL $f_{P40...P45}(H-DIST)$	$VOL\% = VOL * \frac{P11 - P10}{H - X_m} + P10$
Parameters to set	P00 P01(a) = 3 P02(b) P04 = H P05 $\geq X_m$ P40...P45	P00 P01(a) = 4 P02(b) P04 = H P05 $\geq X_m$ P10 = $X_{0\%}$ P11 = $X_{100\%}$ P40...P45

- A:** Shortest measurable distance
- B:** Volume (content) pertaining to the greatest measurable level
- C:** Whole value of the vessel
- D:** diagram valid for the default value of P10 P11

a	Temperature
0	°C
1	°F

This table is interpreted according to P00(c), P01(a) and P02(c) and is irrelevant in case of percentage measurement [P01(a)= 2 or 4]

b	Volume		Weight (set also P32)		Volume flow	
	Metric	US	Metric	US	Metric	US
0	m ³	ft ³	-	lb (pound)	m ³ /time	ft ³ /time
1	liter	gallon	tons	tons	liter/time	gallon/time

c	Time
0	s
1	min
2	hour
3	day

Attention!

EasyTREK is a level transmitter. Although it can be used for measuring weight, due to factors involved in doing so, accuracy may essentially be influenced.

This is the only parameter that has to be programmed for each application other than distance (however to avoid disturbing effect of possible multiple echoes it is suggested to do this in distance measurement applications too).

The maximum distance to be measured is the greatest distance between the surface of the transducer and the farthest level to be measured. The factory programmed, greatest distances (DEFAULT values) which **can be measured** by the units are listed in the table below. For the actual application the maximum distance **to be measured** i.e., the distance between the sensor and the bottom of the tank should be entered in P04.

EasyTREK Level transmitter for liquids	Maximum measuring distance X _M [m (ft)]	
	Transducer material PP / PVDF	Transducer material PTFE
SP□-39	4 (13)	3 (10)
SP□-38	6 (20)	5 (17)
SP□-37	8 (26)	6 (20)
SP□-36	10 (33)	-
SP□-34	15 (49)	-
SP□-32	25 (82)	-

Since the **level** is determined by calculating the difference between the **value set in P04** and **distance (DIST) is measured** by the unit, it is essential that the correct value of (H) is set in **P04**. To obtain the best accuracy it is suggested that this distance is measured in the empty tank.

P05: - - - - Minimum measuring distance (Dead zone – Close-end blocking)**FACTORY DEFAULT: X_m as per chart**

The range, beginning with the sensor's surface, within which (due to the physical restraint of the ultrasound measurement system) measurement cannot be made, is called the dead zone. The **EasyTREK** will not accept any echo within the blocking distance set here.

Close-end blocking may be represented as the extension of the dead zone within which a possible echo will not be taken into consideration making possible to exclude disturbing objects near to the sensor.

Automatic Close-end blocking =Dead Band control (P05 = X_m)

Device with factory default will automatically set the *smallest possible dead band* depending on the conditions of the operation. This will be under optimal conditions a bit smaller in unfavorable circumstances greater than value given in the chart.

Manual Close-end-blocking with limitation \geq dead zone (P05 > X_m)

By entering a value, higher than the factory default the close-end blocking will be either the value programmed in P05 or the actual dead zone distance (influenced by the actual conditions of the application) whichever is greater.

EasyTREK Level transmitter for liquids	Minimum measuring distance X_m [m (in)]	
	Sensor material PP / PVDF	Sensor material PTFE
S-39	0.2 (8)	0.25 (10)
S-38	0.25 (10)	
S-37	0.35 (14)	0.35 (14)
S-36		–
S-34	0.45 (18)	–
S-32	0.6 (24)	–

Far-end blocking is the range below the level set in parameter P06. The far-end blocking can be used to avoid disturbing effect of stirrer or heaters at the bottom of the tanks. Detecting echoes in this range the unit provides special signals.

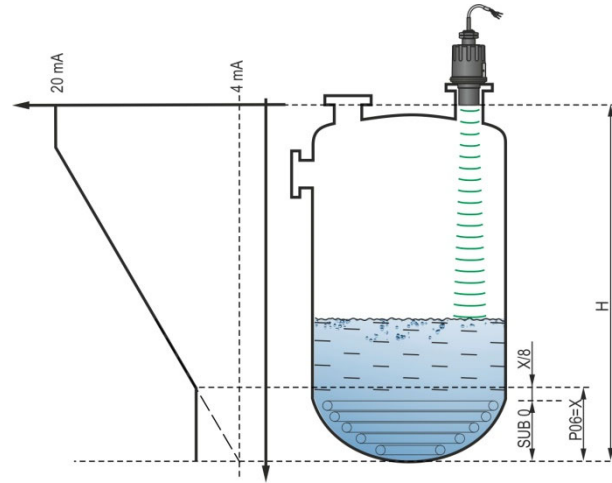

A.) Measuring level or content

Level sinking below

- the value of P06 current output is according to the value of the far-end blocking and further
- below SUB 0 (7/8 of P06) the ERROR CODE 10 will be transmitted via HART

- *Level rising over value of far-end blocking:*

The calculation of level and volume will be based on the programmed tank dimensions, therefore the measured or calculated process values will not be influenced in any way, by the far end blocking value.

B.) Open channel flow metering

Far-end blocking will be used for those small levels below which the accurate volume flow calculation is no longer possible.

- *Level in the flume/weir sinking below the blocked-out range:*
 - Output current value will be according to the value of Q = 0
 - 0 value transmitted via HART for display of „No Flow“ or 0

- *Level in the flume/weir rising over the blocked-out range:*

The calculation of volume flow will be based on the programmed flume/weir data; therefore, the measurement values will not be influenced in any way, by the far end blocking value.

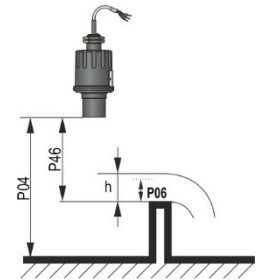

5.3.2. CURRENT OUTPUT

P08: - - - Fixed current output

FACTORY DEFAULT: 0

By this step the output current can be set for a fix value selected from between 3.8 mA and 20.5 mA. This function is not operational as per the factory default: 0. **Attention: fixing output current will make settings in P10, P11, P12 and P19 irrelevant.**

P10: - - - Value (of distance, level, volume or flow) assigned to 4 mA current output

FACTORY DEFAULT: 0

P11: - - - Value (of distance, level, volume or flow) assigned to 20 mA current output

FACTORY DEFAULT: $X_M - X_m$

Values are interpreted according to **P01(a)**. Assignment can be made so that the proportion between the change of the (measured or calculated) process value and the change of the current output be either direct or inverse. E.g., level 1 m assigned to 4mA and level 10 m assigned to 20 mA represents direct proportion and level 1 m assigned to 20 mA and level 10 m assigned to 4 mA represents the inverse proportion. Please note that in case of programming for (LEV or VOL) % measurement the min and max value has to be entered in the relevant engineering units of LEV (m, ft) or VOL (m³, ft³).

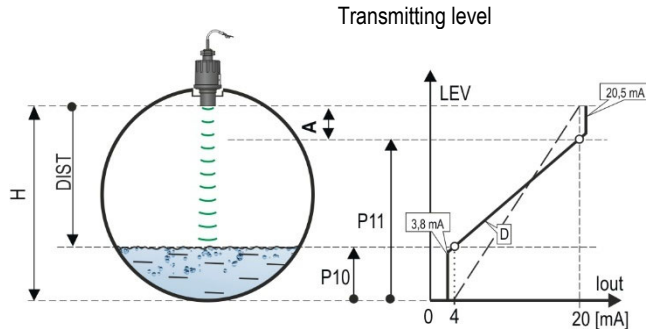

A: Smallest measurable dist.
D: diagram valid for default values of P10 and P11

P12: - - - a Error indication by the current output

FACTORY DEFAULT: 0

In case of error the **EasyTREK** will provide one of the current outputs below for the time the error prevails. (For errors see Chapter 7).

a	Error indication by output current
0	HOLD (hold last value)
1	3.8 mA
2	22 mA

5.3.3. RELAY OUTPUT

P13: --- a Relay function

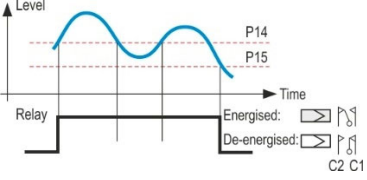
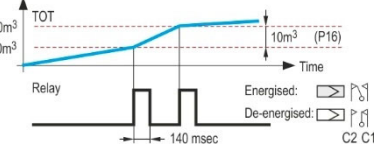
a	Relay function	Also set:	
0	<p>DIFFERENTIAL LEVEL CONTROL (Hysteresis control)</p> <p>Relay is energized if the measured or calculated value exceeds the value set in P14</p> <p>Relay is de-energized if the measured or calculated value descends under the value set in P15</p>		<p>P14, P15</p> <p>There is a need to set (in level min 20mm [0.8 inch]) hysteresis between P14 and P15</p> <p>P14 > P15 – normal operation P14 < P15 – inverted operation</p>
1	Relay is energized in case of Echo Loss	-	
2	Relay is de-energized in case of Echo Loss	-	
3	<p>COUNTER</p> <p>Used for open channel flow metering.</p> <p>A 140 msec pulse is generated every 1, 10, 100, 1.000 or 10.000 m³ according to P16.</p>		<p>P16= 0: 1m³ P16= 1: 10 m³ P16= 2: 100 m³ P16= 3: 1.000 m³ P16= 4: 10.000 m³</p>

In de-energized state of the device the „C1” circuit is closed.

FACTORY DEFAULT: 2

P14: ...	Relay parameter – Operating value	FACTORY DEFAULT: 0
P15: ...	Relay parameter – Releasing value	FACTORY DEFAULT: 0
P16: ...	Relay parameter – Pulse rate	FACTORY DEFAULT: 0

FACTORY DEFAULTS: P14=0, P15=0, P16=0

5.3.4. DIGITAL COMMUNICATION

P19: --- a Short (HART) address of the unit FACTORY DEFAULT: 2

These addresses with 0 – 15 are, in accordance with the HART standard, for distinguishing units in the same loop.

- Address: 0 current output of 4...20 mA operational
- Address: 1 – 15 current output is fixed to 4 mA.

5.3.5. MEASUREMENT OPTIMIZATION

P20: --- a Damping FACTORY DEFAULT: 5

This parameter can be used to reduce unwanted fluctuation of the display and output.

a	Damping (s)	No or moderate fume / waves	Heavy or dense fume or turbulent waves
0	no filter	For testing only	
1	3	applicable	not recommended
2	6	recommended	applicable
3	10	recommended	recommended
4	30	recommended	recommended
5	60	recommended	recommended

P22: --- a Dome top tank compensation FACTORY DEFAULT: 0

This parameter can be used to reduce disturbing effect of possible multiple echoes

a	Compensation	Remark
0	OFF	In case the EasyTREK is not mounted in the center of the top and the top is flat.
1	ON	In case the EasyTREK is mounted in the center of a tank with dome-shaped top

P24: --- a Target tracking speed FACTORY DEFAULT: 0

In this parameter evaluation can be speed up at the expense of the accuracy.

a	Tracking speed	Remark
0	Standard	For most applications
1	Fast	For fast changing level
2	Special	Only for special applications (measuring range is reduced to 50% of the nominal value) The measuring window is inactive and the EasyTREK will respond practically instantly to any target.

P25: - - - a Selection of Echo within the measuring window**FACTORY DEFAULT: 0**

A so-called measuring window is formed around the echo signal. The position of this measuring window determines the flight time for calculation of the distance to the target. (the picture below can be seen on the test oscilloscope)

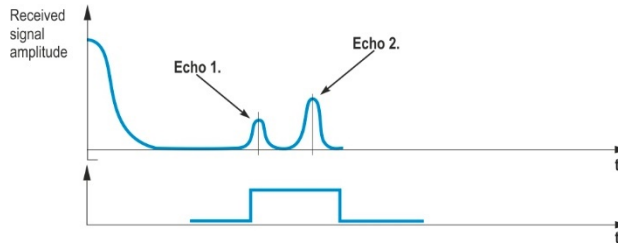

Some applications involve multiple (target + disturbing) echoes even within the measuring window. Basic echo selection will be done by the Quest + software automatically. This parameter influences the echo selection only within the measuring window.

a	Echo in the window to be selected	Remark
0	With the highest amplitude	Most frequently used
1	First one	For liquids applications with multiple echoes within the Measuring Window

P26: - - - Level elevation rate (filling speed) (m/h or ft/h)**FACTORY DEFAULT: 2000****P27: - - - Level descent rate (emptying speed) (m/h or ft/h)****FACTORY DEFAULT: 2000**

These parameters provide additional protection against echo loss in applications involving very heavy fuming. Correct setting increases reliability of the measurement during filling and emptying. The parameters must not be smaller than the fastest possible filling/emptying rate of the actual technology.

Attention! Level changing rate is rather different near to the conical or spherical bottom of such a vessel.

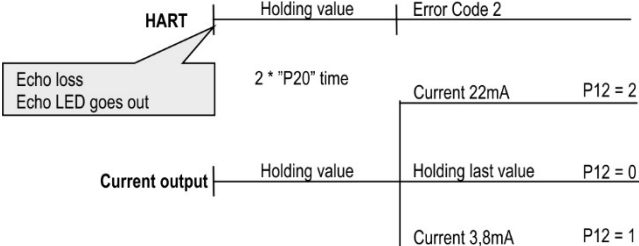
a	Echo loss indication	Remark
0	Delayed indication	<p>During short echo-loss (for the period of twice the time set in P20) analogue output will hold last value. After this period the current value according to the setting in P12 and via HART ERROR CODE 2 will be transmitted.</p> 
1	No indication	For the time of echo-loss, analogue output will hold last value.
2	Filling simulation	Loosing echo during the filling process, transmitted value will increase according to the filling speed set in P26
3	Immediate indication	Loosing echo, the current value (according to the setting in P12) and the ERROR CODE 2 (via HART) will immediately be transmitted.
4	Empty tank indication	Echo-loss may occur in completely empty tanks with a spherical bottom due to deflection of the ultrasonic beam, or in case of silos with an open outlet. In such cases it may be useful to indicate empty tank instead of echo loss.

P29 - - - - Blocking out of disturbing object**FACTORY DEFAULT: 0**

One fixed object in the tank, disturbing the measurement, can be blocked out. By the use of the Echo Map (**P70**) the precise distance of disturbing object can be read out. This value should be entered in this parameter.

P31: - - - - Sound velocity at 20 °C (m/s or ft/s depending on P00(c))**FACTORY DEFAULT: 343,8 (m/s), 1128 (ft/s)**

This parameter should be used if the sound velocity in the gases above the measured surface differs largely from that of in the air. This is recommended for applications where the gas is more or less homogeneous. If it is not, the accuracy of the measurement can be improved using 32-point linearization (**P48, P49**).

For sound velocities in various gases see section "Sound Velocities".

P32: - - - - Specific gravity**FACTORY DEFAULT: 0**

Entering a value (other than "0") of specific gravity in this parameter, the weight will be displayed instead of VOL.

Engineering unit should be [kg/dm³] or [lb/ft³] depending on **P00** (c)

5.3.6. DATA LOGGER

The logger of the device can store 12288 events. The registry is in a non-volatile (FLASH) memory, so the registry will retain its contents even in case of a power failure. The on-board clock of the device is protected against short power-outs, and keeps working for at least 15 days after the device is switched off. The battery protecting the clock needs at least two hours to be recharged.

The logger operates in two basic ways.

Linear logging, whereby an entry is logged after every time period configured in P35.

Event-controlled logging, whereby an entry is logged after an internal event occurs or condition is fulfilled.

The capacity of the registry allows the following logging times in linear logging mode:

P35 [min]	Time of logging	Note
0	3...5 hrs.	depends on device type and measurement cycle time
1	7...8 days	
5	40 days	
10	80 days	
60	500 days (16 months)	

Content of a log:

- entry time (with an accuracy of 1 minute)
- primary measured value (P01)
- level and distance values
- sensor temperature
- output current
- error and status variables

The registry can be erased in parameter P79. See: P79.

P34: - cba Logging mode

a	Operating mode	Parameters to be programmed
0	No logging	
1	Linear logging	P35 interval (minute)
2	Event-controlled logging when the primary value changes	P35 absolute value of variation
3	Event-controlled logging when the primary value changes	P35 variation in %
4	Event-controlled logging when the primary value gets out of range	P35, P36 – absolute values of range limits

b	Logging of errors and warnings (a > 0)
0	No logging
1	Logging of all errors and warnings
2	Logging of errors only
3	Logging of NoEcho only

c	Logging of changes in status (a > 0)
0	No logging
1	Logging of change in status

FACTORY SETTING: 000 (no logging)

Errors that may generate an entry if P34/b<>0: NOECHO, ERR12, ERR13, ERR14, ERR15, ERR16, SUB0, ERR4, ERR5, PT ERR (temperature measurement error).

P34a	Operating mode	Function of P35 and P36
0	No logging	
1	Linear logging	<p>P35 = 0 One entry after every measurement cycle. P35 <> 0 Logging interval (minutes) P36 Value is indifferent</p>
2	Event-controlled logging when the primary value changes	<p>P35 Absolute value of the change in the primary measured value (according to P01a) P35 is defined as the dimension of the primary measured unit. Log entry occurs if the value of the primary measured value deviates from the measured value of the previous cycle in any direction by the amount specified in P35. P36 Value is indifferent</p>
3	Event-controlled logging when the primary value changes	<p>P35 Relative (%) value of primary measured value (according to P01a) variation. P35 is a relative quantity so its dimension is percent. Log entry occurs if the value of the primary measured value deviates from the measured value of the previous cycle in any direction by the amount specified in P35. P36 Value is indifferent</p>
4	Event-controlled logging when the primary value gets out of range in any direction	<p>P35, P36 Absolute values of the limits of the range of the primary measured values (according to P01a). P35 and P36 have the same dimension as the primary measured value. Log entry occurs if the value of the primary measured value steps over the limit given in P35 and P36, in any direction. To monitor only one limit value, set it in P35 and let P36 be 0.</p>

FACTORY SETTING: P35 = 0, P36 = 0

P37: yyyy Real-time clock, year

Year setting for date of the on-board clock. (2005)

P38: mmdd Real-time clock, month and day

Month (mm) and day (dd) setting for date of the on-board clock.

P39: HHMM Real-time clock, hour and minute

Hour (HH) and minute (MM) setting of the on-board clock.

5.3.6.1 READING DATA OUT FROM THE LOGGER

Reading the logger is only possible with digital communication. For this purpose, the built-in IrDA communication port can be used. The content of the log can also be read out via HART communication, but because of the slow speed of HART, it takes several hours. To access the data content use of NIVELCO's DataScope program is recommended. During this high-speed communication the device sets the output current to 22 mA. There is no measurement while retrieving data from the register, so measurement values are not updated.

Connecting to a PC using an IrDA adapter:

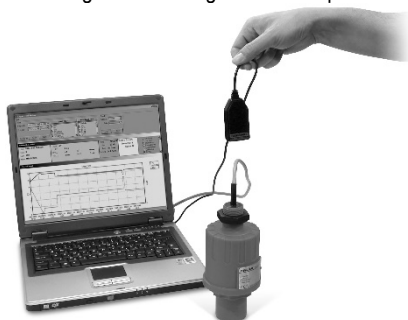

The IrDA adapter and the IrDA port of the device must be placed within a 5...10 cm distance and facing each other!

Recommended IrDA adapters:

(only IrDA to RS232 adapters can be used)*

- RedSnake:

- ActiSys:

- Esis:

IL-200

ACT-IR200S

ACT-IR220L+

ACT-IR220LR

M8421

* Recommended RS232-USB adapters for using the USB port: STLab: USB-RS232
MOXA: NPort-U1110, UPort 1110

After connecting the adapters start DataScope program. The program and the User's Manual can be found on the website of NIVELCO.

5.3.7. VOLUME (CONTENT) MEASUREMENT

P40: - - ba Tank shape

FACTORY DEFAULT: 00

ba	Tank shape	Programmable parameters
b0	Standing cylindrical tank shape (value of "b" as below)	P40 (b), P41
01	Standing cylindrical tank with conical bottom	P41, P43, P44
02	Standing rectangular tank (with chute)	P41, P42, P43, P44, P45
b3	Lying cylindrical tank shape (value of "b" as below)	P40 (b), P41, P42
04	Spherical tank	P41

Attention!
The value „a" determining the shape of the tank should be set first.

P41-45: - - - Tank dimensions

FACTORY DEFAULT: 0

Standing cylindrical tank with hemispherical bottom a = 0	Standing cylindrical tank with conical bottom a = 1 b = 0	Standing rectangular tank with or without chute a = 2 b = 1
Lying cylindrical tank a = 3		Spherical tank a = 4, b = 0

Plain bottom
P43, P44 and
P45 = 0

5.3.8. OPEN CHANNEL FLOW MEASUREMENT

P40: - - b a Devices, formula, data

FACTORY DEFAULT: 00

ba	Devices, formula, data					Programmable parameters	
	Type	Formula	Qmin [l/s]	Qmax [l/s]	"P" [cm]		
00	NIVELCO Parshall channels	GPA-1P1	$Q [l/s] = 60.87 * h^{1.552}$	0.26	5.38	30	P46
01		GPA-1P2	$Q [l/s] = 119.7 * h^{1.553}$	0.52	13.3	34	P46
02		GPA-1P3	$Q [l/s] = 178.4 * h^{1.555}$	0.78	49	39	P46
03		GPA-1P4	$Q [l/s] = 353.9 * h^{1.558}$	1.52	164	53	P46
04		GPA-1P5	$Q [l/s] = 521.4 * h^{1.558}$	2.25	360	75	P46
05		GPA-1P6	$Q [l/s] = 674.6 * h^{1.556}$	2.91	570	120	P46
06		GPA-1P7	$Q [l/s] = 1014.9 * h^{1.556}$	4.4	890	130	P46
07		GPA-1P8	$Q [l/s] = 1368 * h^{1.5638}$	5.8	1208	135	P46
08		GPA-1P9	$Q [l/s] = 2080.5 * h^{1.5689}$	8.7	1850	150	P46
09	General PARSHALL flume					P46, P42	
10	PALMER-BOWLUS (D/2)					P46, P41	
11	PALMER-BOWLUS (D/3)					P46, P41	
12	PALMER-BOWLUS (Rectangular)					P46, P41, P42	
13	Khafagi Venturi					P46, P42	
14	Bottom-step weir					P46, P42	
15	Suppressed rectangular or BAZIN weir					P46, P41, P42	
16	Trapezoidal weir					P46, P41, P42	
17	Special trapezoidal (4:1) weir					P46, P42	
18	V-notch weir					P46, P42	
19	THOMSON (90°-notch) weir					P46	
20	Circular weir					P46, P41	
21	General flow formula: $Q [l/s] = 1000 * P41 * h^{P42}$, h [m]					P46, P41, P42	

P40=00 NIVELCO Parshall flumes (GPA1P1 ... GPA-1P9)
 .
 . For further details see the Manual of the Parshall flume
 .
 .

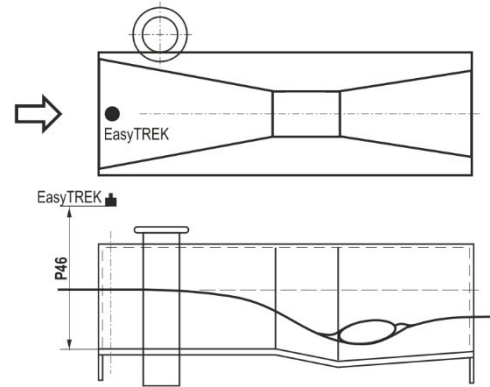

P40=09 General Parshall flume
 0.305 < P42(width) < 2.44

$$Q [l/s] = 372 \times P42 \times (h / 0.305)^{1.569 \times P42^{0.026}}$$

$$2.5 < P42$$

$$Q [l/s] = K \cdot P42 \cdot h^{1.6}$$

$$P = 2/3 \cdot A$$

P42 [m]	K
3.05	2.450
4.57	2.400
6.10	2.370
7.62	2.350
9.14	2.340
15.24	2.320

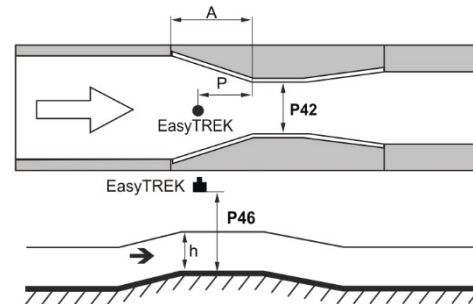

P40= 10

Palmer-Bowlus (D/2) flume

$Q \text{ [m}^3\text{/s]} = f(h1/P41) \cdot P41^{2.5}$, where $h1\text{[m]} = h + (P41/10)$

P41 [m]

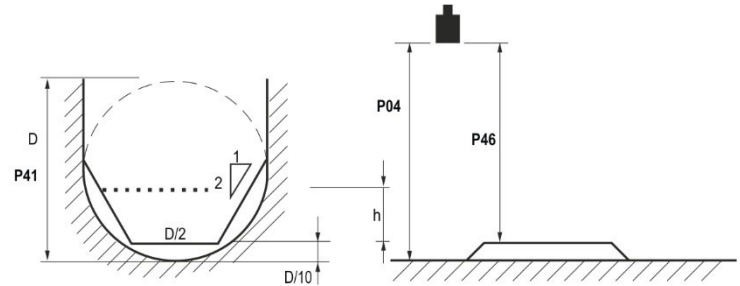

P40= 11

Palmer-Bowlus (D/3) flume

$Q \text{ [m}^3\text{/s]} = f(h1/P41) \cdot P41^{2.5}$, where $h1\text{[m]} = h + (P41/10)$

P41 [m]

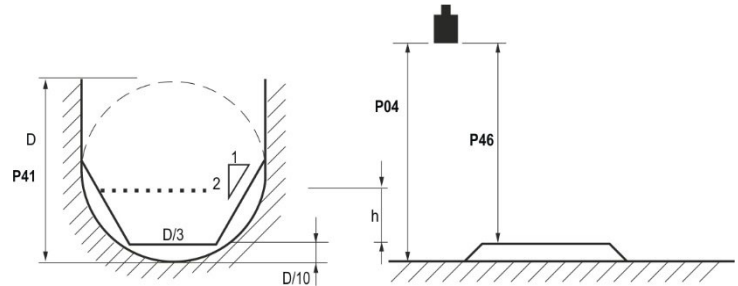

P40= 12

Palmer-Bowlus (rectangular) flume

$Q \text{ [m}^3\text{/s]} = C \cdot P42 \cdot h^{1.5}$, where $C = f(P41/P42)$

P41 [m], P42 [m]

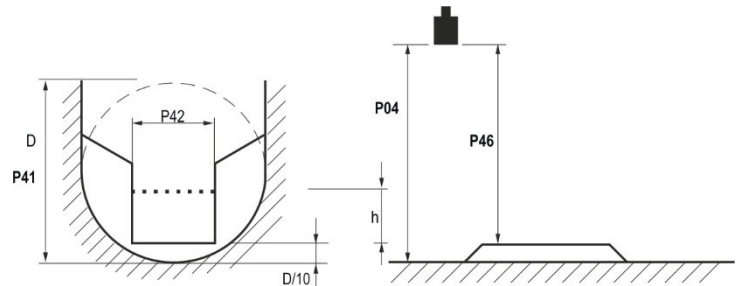

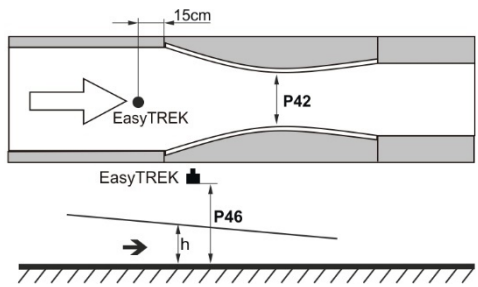
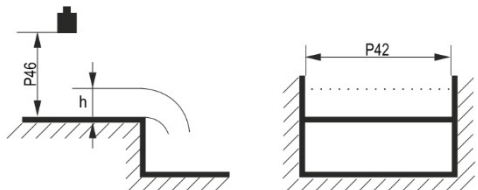
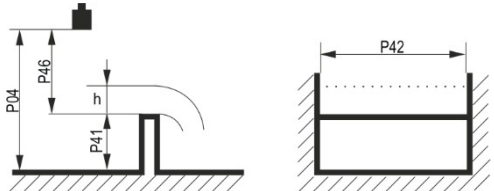
<p>P40= 13</p> <p>Khafagi Venturi flume</p> <p>$Q \text{ [m}^3\text{/s]} = 1.744 \cdot P42 \cdot h^{1.5} + 0.091 \cdot h^{2.5}$</p> <p>P42 [m]</p> <p>h [m]</p>	
<p>P40= 14</p> <p>Bottom step weir</p> <p>$0.0005 < Q \text{ [m}^3\text{/s]} < 1$</p> <p>$0.3 < P42 \text{ [m]} < 15$</p> <p>$0.1 < h \text{ [m]} < 10$</p> <p>$Q \text{ [m}^3\text{/s]} = 5.073 \cdot P42 \cdot h^{1.5}$</p> <p>Accuracy: $\pm 10\%$</p>	
<p>P40= 15</p> <p>Suppressed rectangular or BAZIN weir</p> <p>$0.001 < Q \text{ [m}^3\text{/s]} < 5$</p> <p>$0.15 < P41 \text{ [m]} < 0.8$</p> <p>$0.15 < P42 \text{ [m]} < 3$</p> <p>$0.015 < h \text{ [m]} < 0.8$</p> <p>$Q \text{ [m}^3\text{/s]} = 1.77738(1+0.1378h/P41) \cdot P42 \cdot (h+0.0012)^{1.5}$</p> <p>Accuracy: $\pm 1\%$</p>	

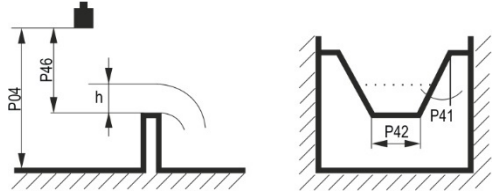
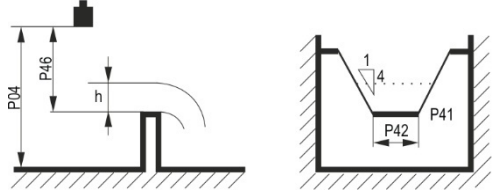
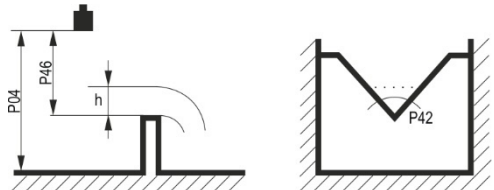
<p>P40= 16</p>	<p>Trapezoidal weir $0.0032 < Q \text{ [m}^3\text{/s]} < 82$ $20 < P41[^\circ] < 100$ $0.5 < P42 \text{ [m]} < 15$ $0.1 < h \text{ [m]} < 2$ $Q \text{ [m}^3\text{/s]} = 1.772 \cdot P42 \cdot h^{1.5} + 1.320 \cdot \text{tg}(P41/2) \cdot h^{2.47}$ Accuracy: $\pm 5\%$</p>	
<p>P40= 17</p>	<p>Special trapezoidal (4:1) weir $0.0018 < Q \text{ [m}^3\text{/s]} < 50$ $0.3 < P42 \text{ [m]} < 10$ $0.1 < h \text{ [m]} < 2$ $Q \text{ [m}^3\text{/s]} = 1.866 \cdot P42 \cdot h^{1.5}$ Accuracy: $\pm 3\%$</p>	
<p>P40= 18</p>	<p>V-notch weir $0.0002 < Q \text{ [m}^3\text{/s]} < 1$ $20 < P42[^\circ] < 100$ $0.05 < h \text{ [m]} < 1$ $Q \text{ [m}^3\text{/s]} = 1.320 \cdot \text{tg}(P42/2) \cdot h^{2.47}$ Accuracy: $\pm 3\%$</p>	

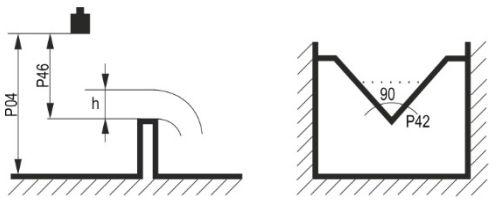
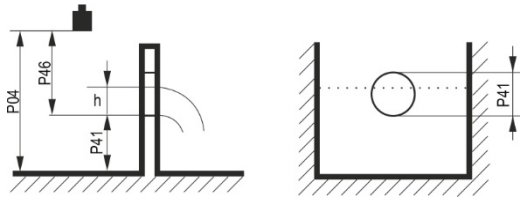
<p>P40= 19</p>	<p>THOMSON (90°-notch) weir</p> <p>$0.0002 < Q \text{ [m}^3\text{/s]} < 1$</p> <p>$0.05 < h \text{ [m]} < 1$</p> <p>$Q[\text{m}^3\text{/s}] = 1.320 \cdot h^{2.47}$</p> <p>Accuracy: $\pm 3\%$</p>	
<p>P40= 20</p>	<p>Circular weir</p> <p>$0.0003 < Q \text{ [m}^3\text{/s]} < 25$</p> <p>$0.02 < h \text{ [m]} < 2$</p> <p>$Q[\text{m}^3\text{/s}] = m \cdot b \cdot D^{2.5}$, where $b = f(h/D)$</p> <p>$m = 0.555 + 0.041 \cdot h/P41 + (P41/(0.11 \cdot h))$</p> <p>Accuracy: $\pm 5\%$</p>	

P46: - - - - Distance at Q=0 **FACTORY DEFAULT: 0**

Distance between sensor surface and the level at which flow starts has to be entered in this parameter.

5.3.9. 32-POINT LINEARIZATION

P47: --- a Linearization

FACTORY DEFAULT: 0

Linearization is the method of assigning requested (calibrated or calculated) level, volume or flow to values measured by the transmitter.

It can be used for instance if the sound velocity is not known (LEVEL⇒LEVEL) or in the case of tank with other shape than under 6.4 or open channel other than under 6.5 (LEVEL ⇒ VOLUME or LEVEL ⇒ FLOW).

a	Linearization
0	OFF (FACTORY DEFAULT)
1	ON

Conditions of correct programming of the data pairs

The table must always start with: $L(1) = 0$ and $r(1) = \text{value (assigned to 0 level)}$

The table must be ended either with the 32nd data pair i.e. $j = 32$ or if the linearization table contains less than 32 data-pairs $j < 32$, it must be ended with a level value "0" e.g. $L(j < 32) = 0$.

The EchoTREK will ignore data after recognizing level value "0" with serial number other than "1".

If the above conditions are not met, error codes will be displayed (see chapter: Error Codes).

i	L (Left column) Level values measured	r (Right column) Value assigned to transmit
1	0	r(1)
2	L(2)	r(2)
	L(i)	r(i)
nn	L(nn)	r(nn)
nn+1	0	
32		

P48: Number of linearization data pairs

Number of linearization data pairs entered in the table.

5.3.10. INFORMATIONAL PARAMETERS (READ OUT PARAMETERS)

P60: - - - - Overall operating hours of the unit (h)

P61: - - - - Time elapsed after last switch-on (h)

P62: - - - - Operating hours of the relay (h)

P63: - - - - Number of switching cycles of the relay

P64: - - - - Actual temperature of the transducer (°C / °F)

Broken loop of the thermometer will be indicated by display of the Pt Error message initiated by a signal sent via HART. In this case the transmitter will perform temperature correction corresponding to 20 °C.

P65: - - - - Maximum temperature of the transducer (°C / °F)

P66: - - - - Minimum temperature of the transducer (°C / °F)

P70: - - - - Number of Echoes / Echo Map

Amplitude and position of the echoes can also be read out.

P71: - - - - Distance of the of Measuring Window

P72 - - - - Amplitude of the selected echo [dB] <0

P73: Position of the selected echo (time) :(ms)[ms]

P74: Signal To Noise Ratio

Ratio	Measurement conditions
Over 70	Excellent
Between 70 and 30	Good
Under 30	Unreliable

P75: - - - - Blocking Distance

The actual close-end blocking distance will be displayed (provided automatic blocking was selected in **P05**).

5.3.11. ADDITIONAL PARAMETERS OF THE FLOW METERING

P76: - - - - Head of flow (LEV) (Read only parameter)

The Headwater value can be checked here. This is the “h” value in the formula for flow calculation.

P77: - - - - TOT1 volume flow totalized (resettable)

P78: - - - - TOT2 volume flow totalized (non-resettable)

5.3.12. SUPPLEMENTARY PARAMETER OF THE LOGGER

P79: Free space of logger in percent

If the value is 0, the registry has overflowed and every new entry will overwrite the oldest one.

Clearing the logger

- 1). Enter parameter **P79**.
- 2). Press **⬅ + ⬇** keys.
- 3). The display flashes „Lo-Clr” message.
- 4). Pressing **Ⓜ** will clear the logger.

5.3.13. OTHER PARAMETERS

P96: - - - - Software code 1 (Read only parameter)

P97: - - - - Software code 2 (Read only parameter)

P98: - - - - Hardware code (Read only parameter)

P99: dcba Access lock by secret code

The purpose of this feature is to provide protection against accidental programming or intentional reprogramming of parameters by a person not entitled to do so. The secret code can be any value other than **0000**. Setting a secret code will automatically be activated when the **EasyTREK** is returned to the Measurement Mode. In order to program locked device, the secret code should be entered first in **P99**. Thus, for entering a new code or erasing the old one the knowledge of the previous code is necessary.

6. MAINTENANCE, REPAIR, AND STORAGE CONDITIONS

The device does not require regular maintenance. The warranty card contains the terms and conditions. Before returning the device for repairs, it must be cleaned thoroughly. The parts in contact with the medium may contain harmful substances; therefore, they must be decontaminated. Our official form ([Returned Equipment Handling Form](#)) must be filled and enclosed in the parcel. Download it from our website www.nivelco.com. The device must be sent back with a declaration of decontamination. A statement must be provided in the declaration that the decontamination process was successfully completed and that the device is clean from any hazardous substances.

Unused devices must be stored within the ambient temperature range specified in the technical data, with a maximum of 98% relative humidity.

6.1 SOFTWARE UPGRADE

Based on the observations & needs of our customers NIVELCO constantly improves and revises the operating software of the device. The software can be upgraded with the help of the IrDA communication port of the device. For more information about software updates please contact NIVELCO.

7. ERROR CODES

Error Code	Error description	Causes and solutions
1	Memory error	Contact local agent
No Echo	Echo loss	See Action 5 and 6
3	Hardware error	Contact local agent
4	Display overflow	Check settings
5	Sensor error or improper installation/mounting, level in the dead band	Verify sensor for correct operation and check for correct mounting according to the User's Manual
6	The measurement is at the reliability threshold	Better location should be found.
7	No signal received within the measuring range specified in P04 and P05	Check programming, also look for installation mistake
12	Linearization table error: both L(1) and L(2) are zero (no valid data-pairs)	See "Linearization" Section
13	Linearization table error: same L(i) data is given twice in the table	See "Linearization" Section
14	Linearization table error: the r(i) values are not monotone increasing	See" Linearization" Section"
15	Linearization table error: measured Level is higher than the last Volume or Flow data-pair	See" Linearization" Section"
16	The check sum of the program is wrong	Contact local agent
17	Parameter consistency failure	Check programming
18	Hardware failure	Contact local agent

8. PARAMETER TABLE

Par.	Page	Description	Value				Par.	Page	Description	Value			
			d	c	b	a				d	c	b	a
P00	16	Application/Engineering Units					P28	24	Echo loss indication				
P01	17	Measurement Mode					P29	25	Blocking out a disturbing object				
P02	19	Calculation units					P30	-	-				
P03	-	-					P31	25	Sound velocity values in different gases				
P04	19	Maximum Measuring Distance					P32	25	Specific gravity				
P05	20	Minimum Measuring Distance					P33	-	-				
P06	21	Far End Blocking					P34	27	Logging mode				
P07	-	-					P35	28	Log value 1 and log value 2				
P08	20	Fixed current output					P36	28	Log value 1 and log value 2				
P09	-	-					P37	29	Real-time clock, year				
P10	22	Transmitted value assigned to „4 mA“					P38	29	Real-time clock, month and day				
P11	22	Transmitted value assigned to „20 mA“					P39	29	Real-time clock, hour and minute				
P12	22	“Error” indication by the current output					P40	30	Selection of tank shape/ open channel				
P13	21	Relay function					P41	30	Dimensions of tank / Open Channel				
P14	21	Relay parameter – Operating value					P42	30	Dimensions of tank / Open Channel				
P15	21	Relay parameter – Releasing value					P43	30	Dimensions of tank / Open Channel				
P16	21	Relay parameter – Pulse rate					P44	30	Dimensions of tank / Open Channel				
P17	-	-					P45	30	Dimensions of tank / Open Channel				
P18	-	-					P46	36	Level pertaining to flow Q = 0				
P19	22	Short address of the unit					P47	37	Linearization				
P20	22	Damping					P48	37	Linearization table				
P21	-	-					P49	-	-				
P22	22	Dome top tank compensation					P50	-	-				
P23	-	-					P51	-	-				
P24	22	Target tracking speed					P52	-	-				
P25	23	Selection of Echo in the measuring window					P53	-	-				
P26	23	Level elevation rate					P54	-	-				
P27	23	Level descent rate					P55	-	-				

Par.	Page	Description	Value			
			d	c	b	a
P56	–					
P57	–					
P58	–					
P59	–					
P60	38	Overall operating hours of the unit				
P61	38	Time elapsed after last switch-on				
P62	38	Operating hours of the relay				
P63	38	Number of switching cycles of the relay				
P64	38	Actual temperature of the transducer				
P65	38	Maximum temperature of the transducer				
P66	38	Minimum temperature of the transducer				
P67	–					
P68	–					
P69	–					
P70	38	Echo Map				
P71	38	Position of the measuring window				
P72	38	Amplitude of the selected echo				
P73	38	Position of the selected echo				
P74	38	Signal / noise ratio				
P75	38	Blocking distance value				
P76	39	Water head of the flow				
P77	39	TOT1 volume flow totalized				

Par.	Page	Description	Value			
			d	c	b	a
P78	39	TOT2 volume flow totalized				
P79	39	Free space of the logger in percent				
P80	–					
P81	–					
P82	–					
P83	–					
P84	–					
P85	–					
P86	–					
P87	–					
P88	–					
P89	–					
P90	–					
P91	–					
P92	–					
P93	–					
P94	–					
P95	–					
P96	39	Software code 1				
P97	39	Software code 2				
P98	39	Hardware code				
P99	39	Access lock by secret code				

9. SOUND VELOCITY VALUES IN DIFFERENT GASES

The following table contains the sound velocity values of various gases measured at +20 °C (+68 °F).

Gases	Formula	Sound Velocity (m/s)
Acetaldehyde	C_2H_4O	252.8
Acetylene	C_2H_2	340.8
Ammonia	NH_3	429.9
Argon	Ar	319.1
Benzene	C_6H_6	183.4
Carbon dioxide	CO_2	268.3
Carbon monoxide	CO	349.2
Carbon tetrachloride	CCl_4	150.2
Chlorine	Cl_2	212.7
Dimethyl ether	CH_3OCH_3	213.4
Ethane	C_2H_6	327.4
Sulphur hexafluoride	SF_6	137.8

Gases	Formula	Sound Velocity (m/s)
Ethanol	C_2H_5OH	267.3
Ethylene	C_2H_4	329.4
Helium	He	994.5
Hydrogen sulfide	H_2S	321.1
Methane	CH_4	445.5
Methanol	CH_3OH	347
Neon	Ne	449.6
Nitrogen	N_2	349.1
Nitrogen monoxide	NO	346
Oxygen	O_2	328.6
Propane	C_3H_8	246.5

spa380en2112p

August 2021

NIVELCO reserves the right to change technical specifications without notice.